

e)

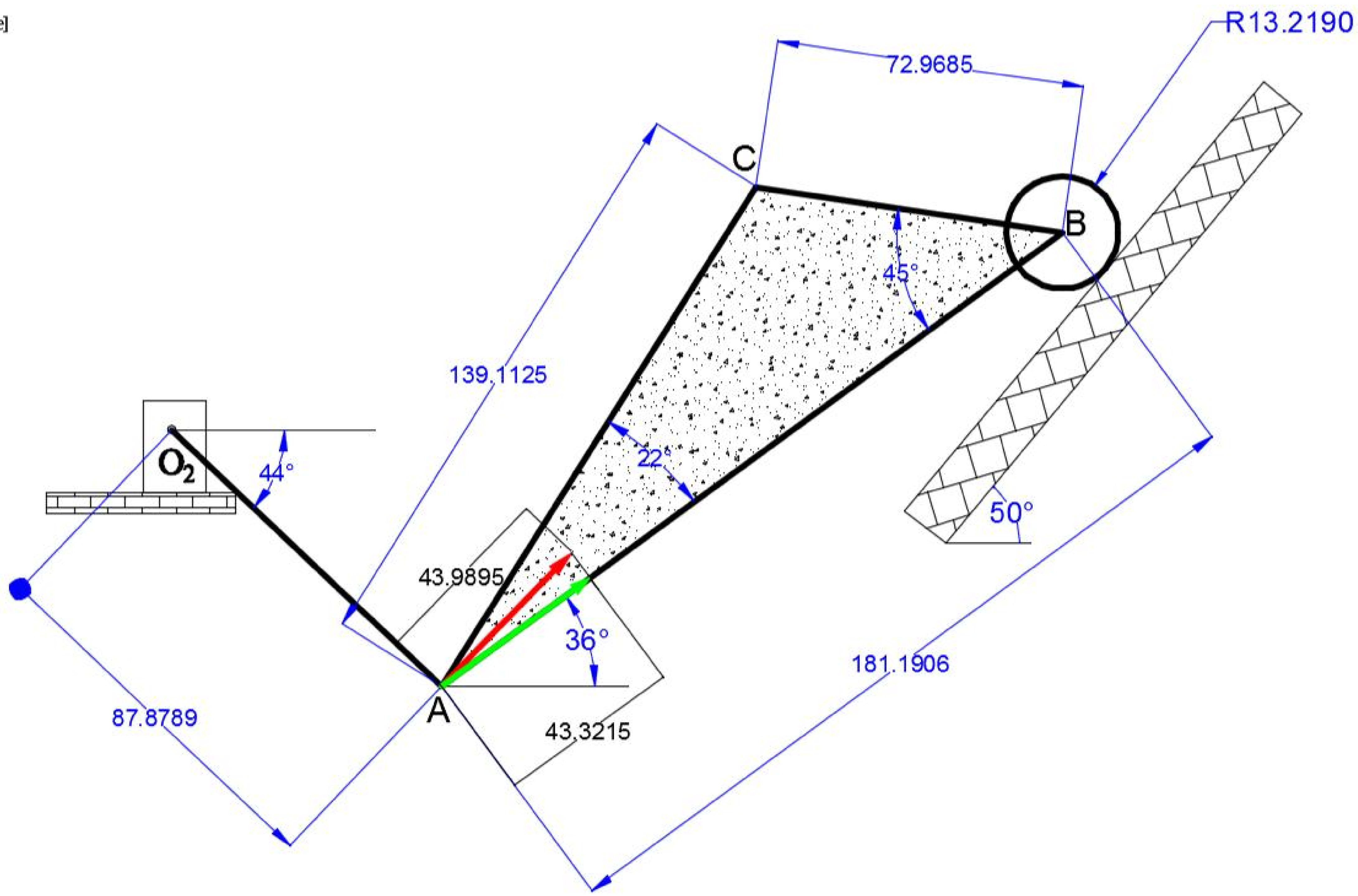

3]

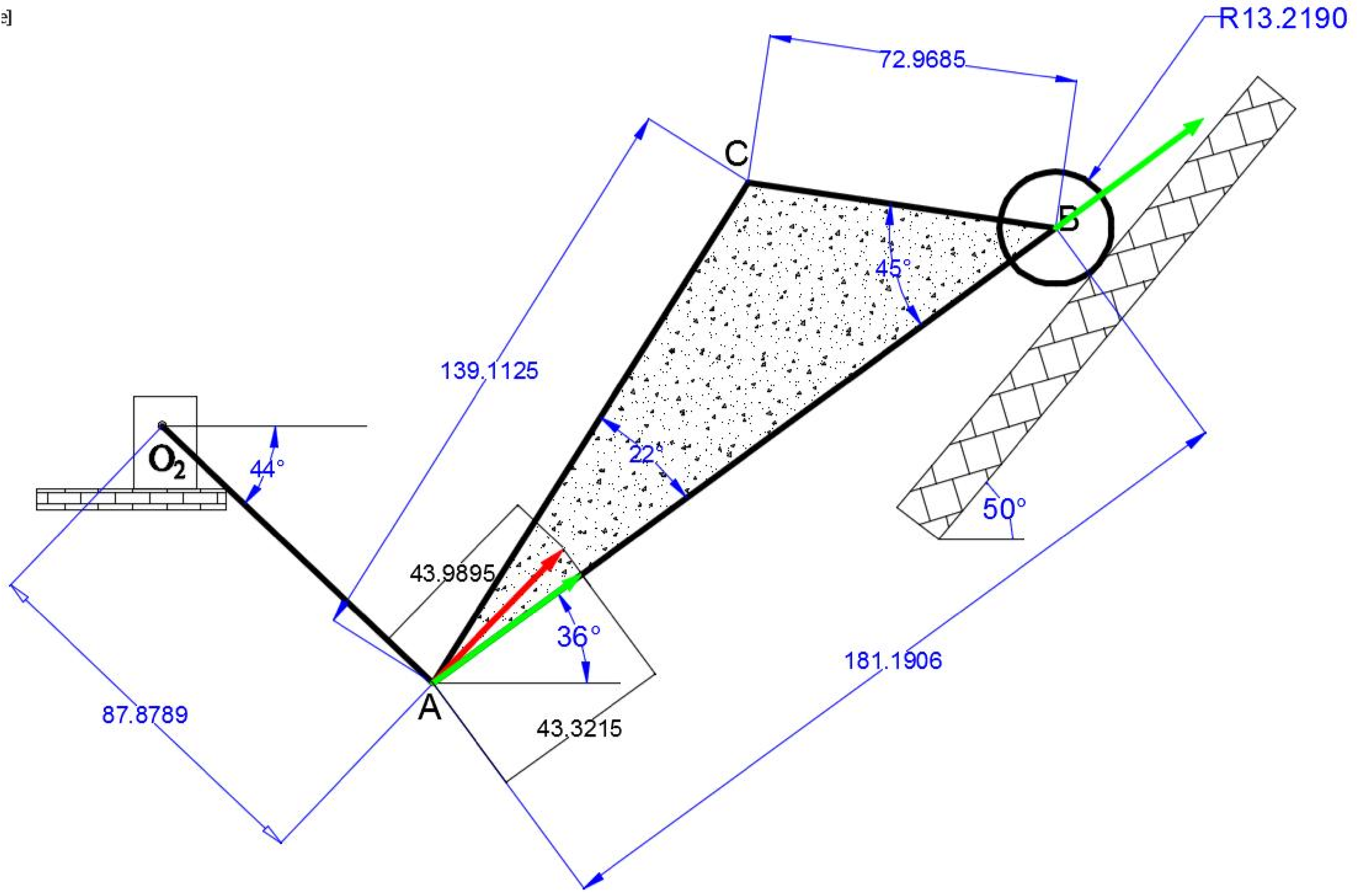

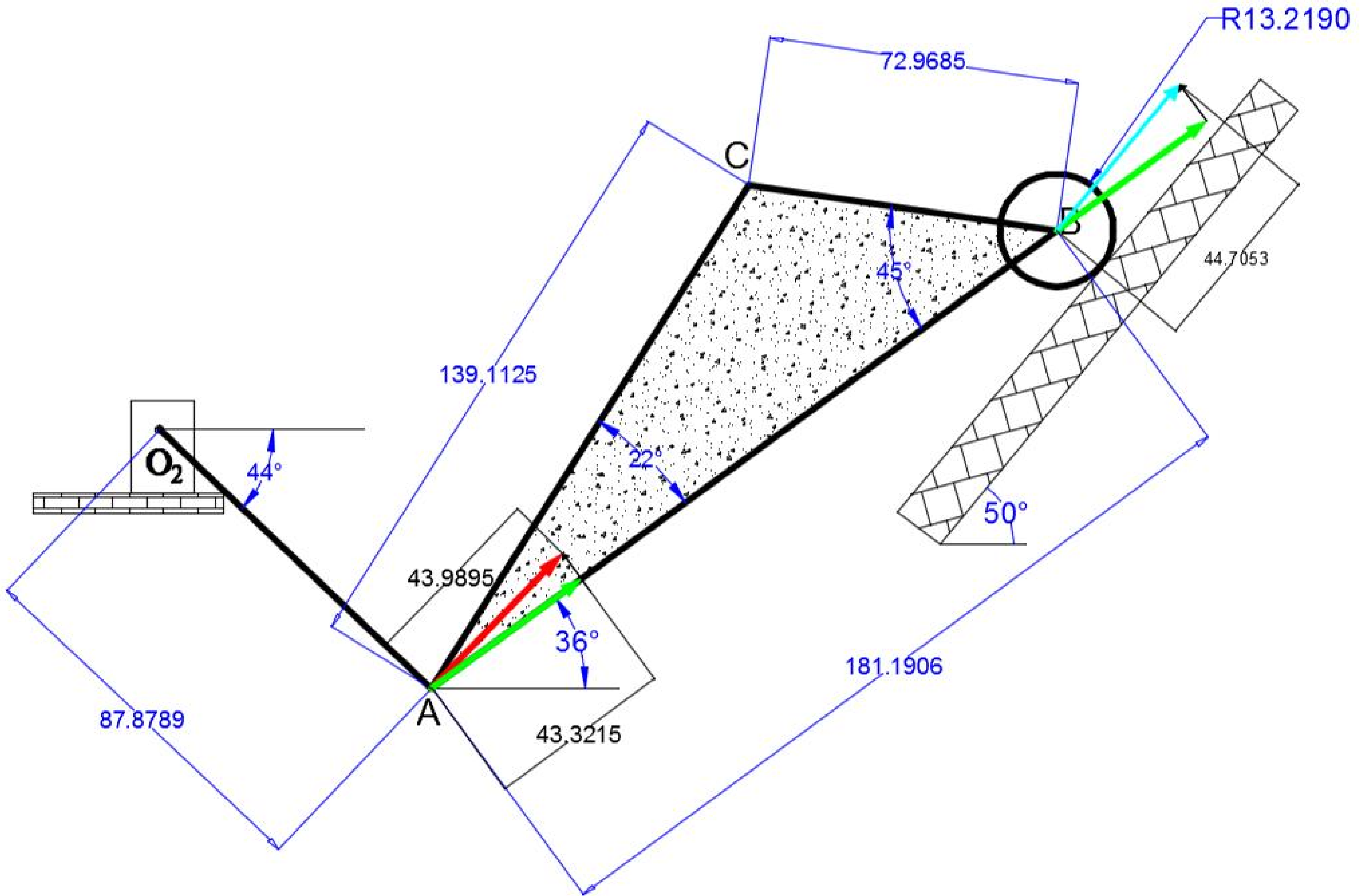

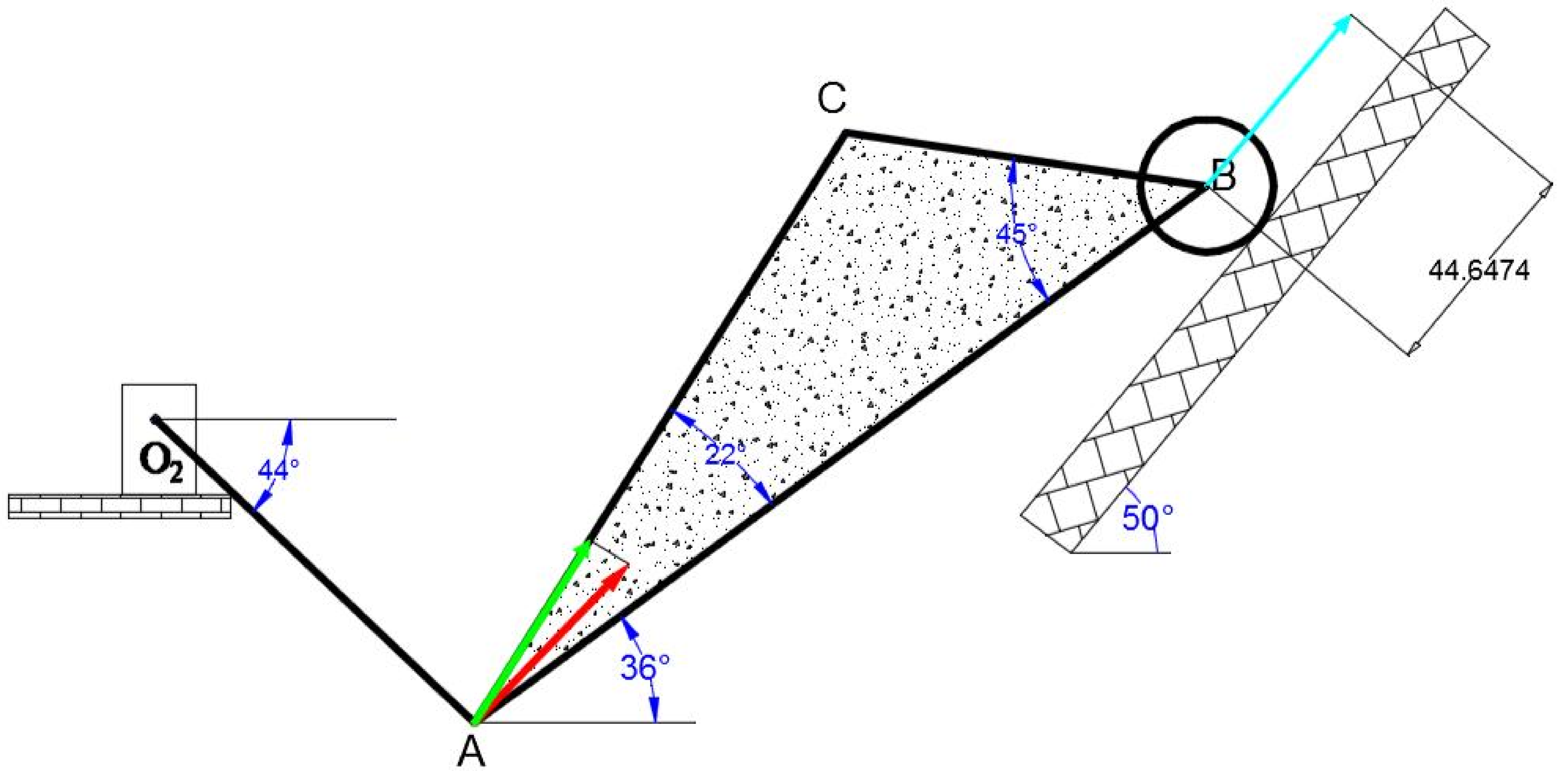

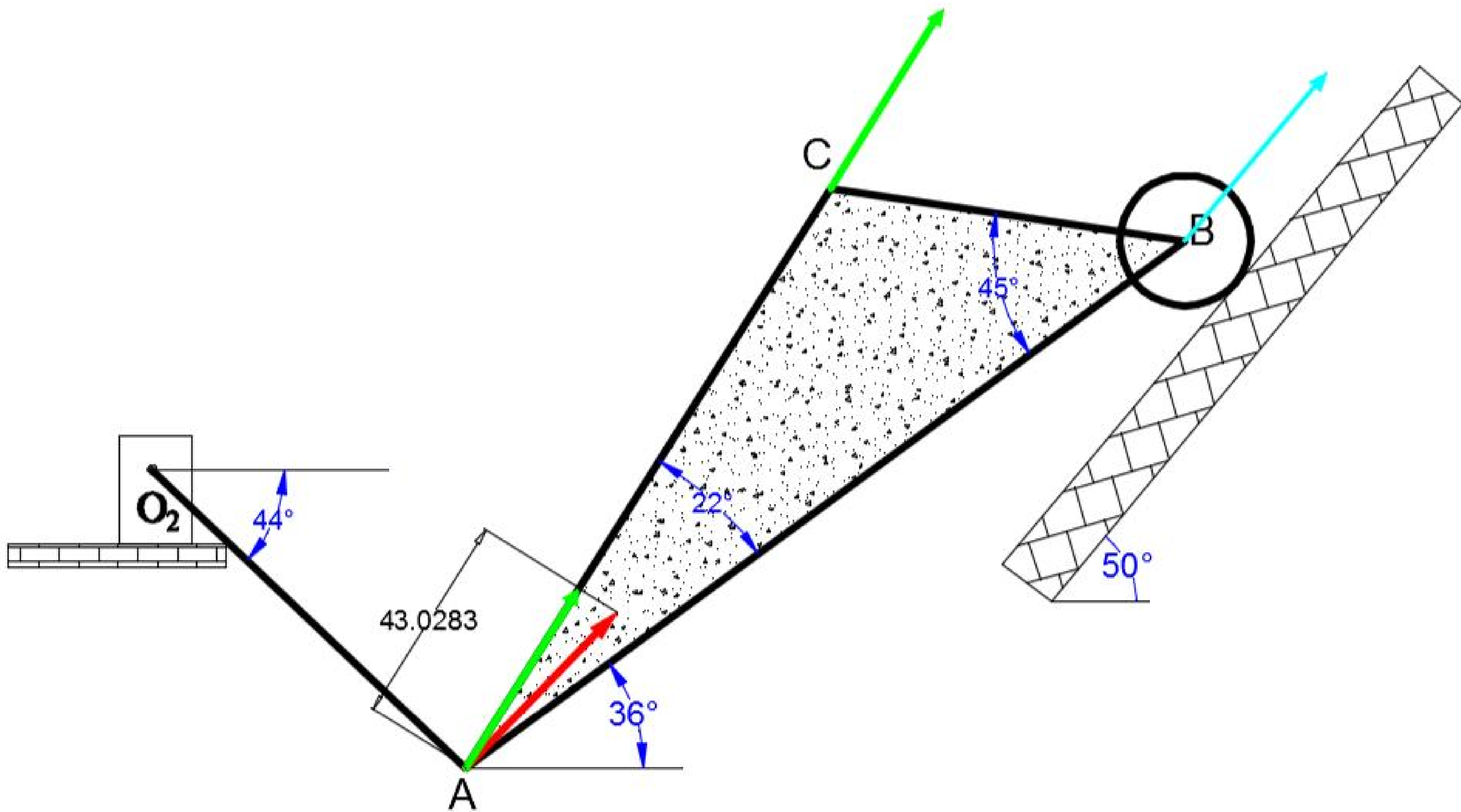

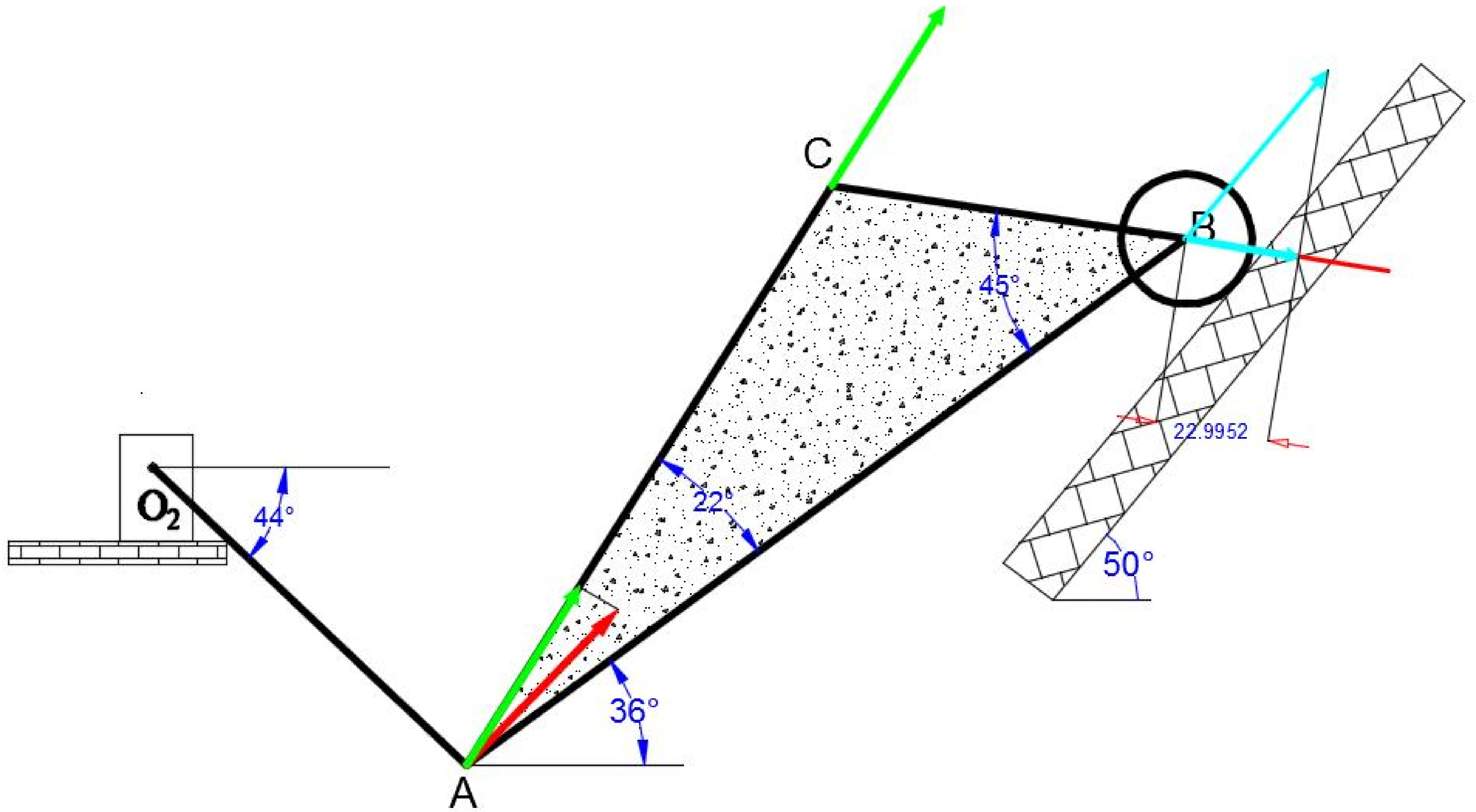



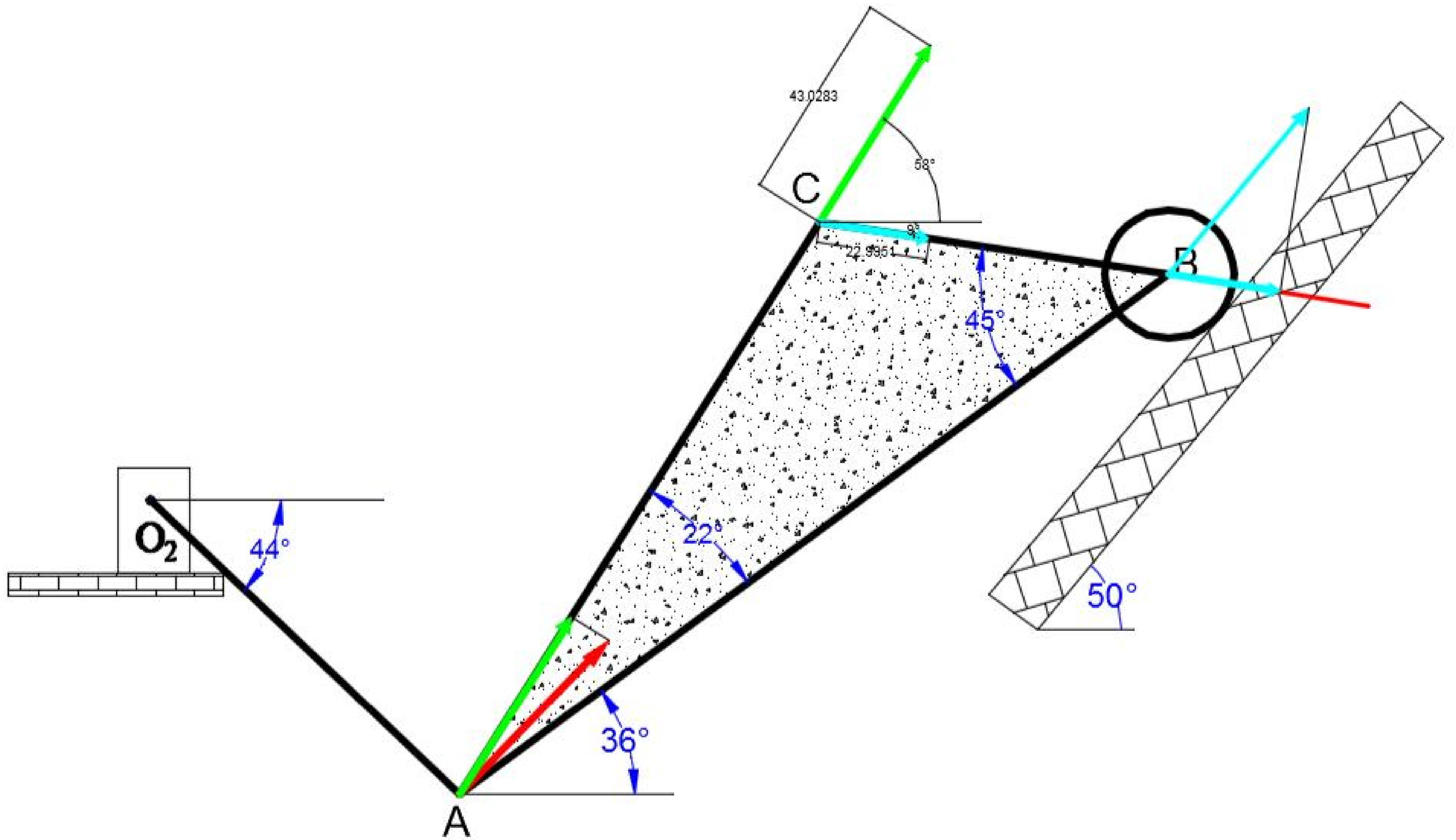

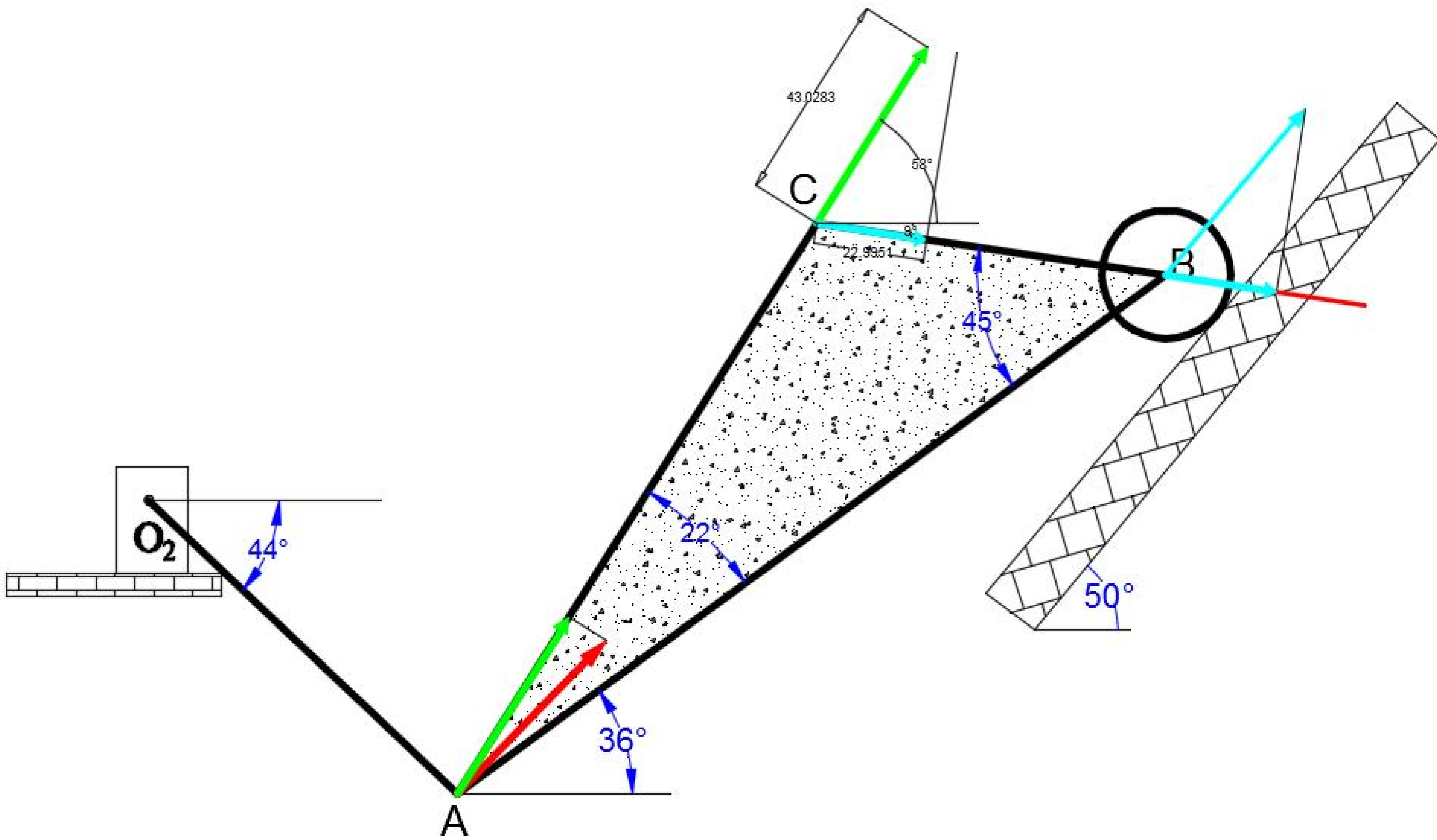

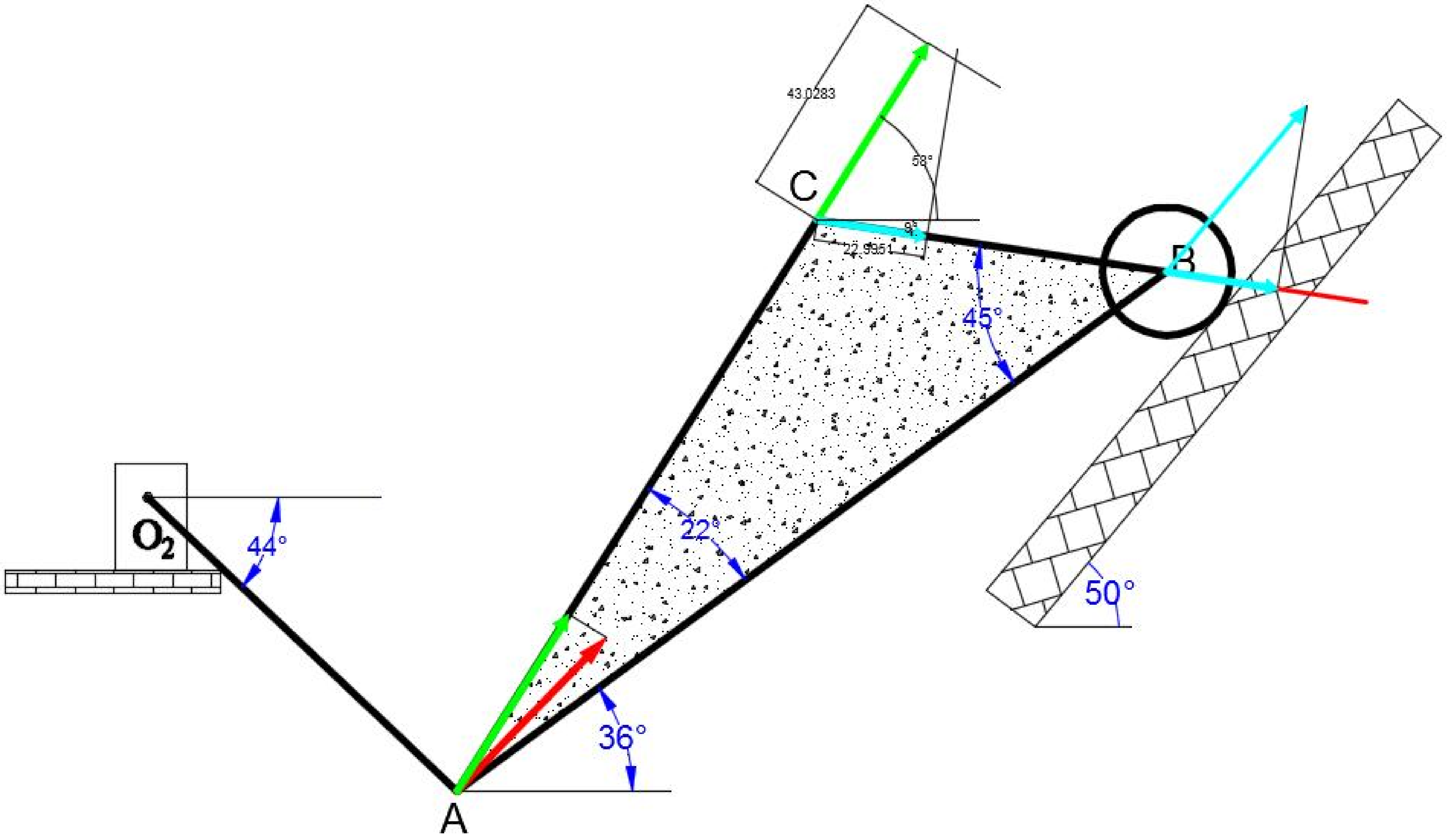

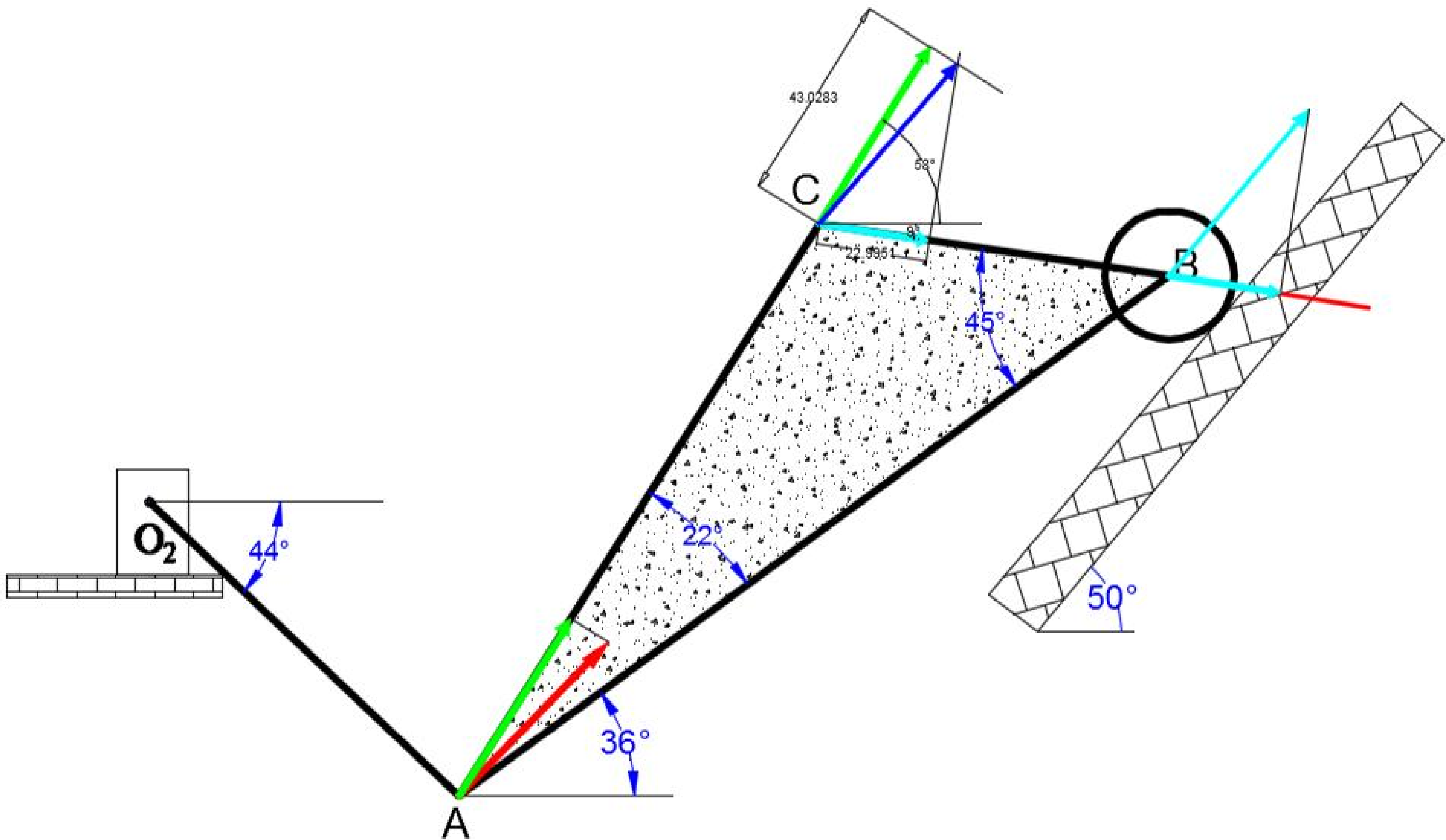

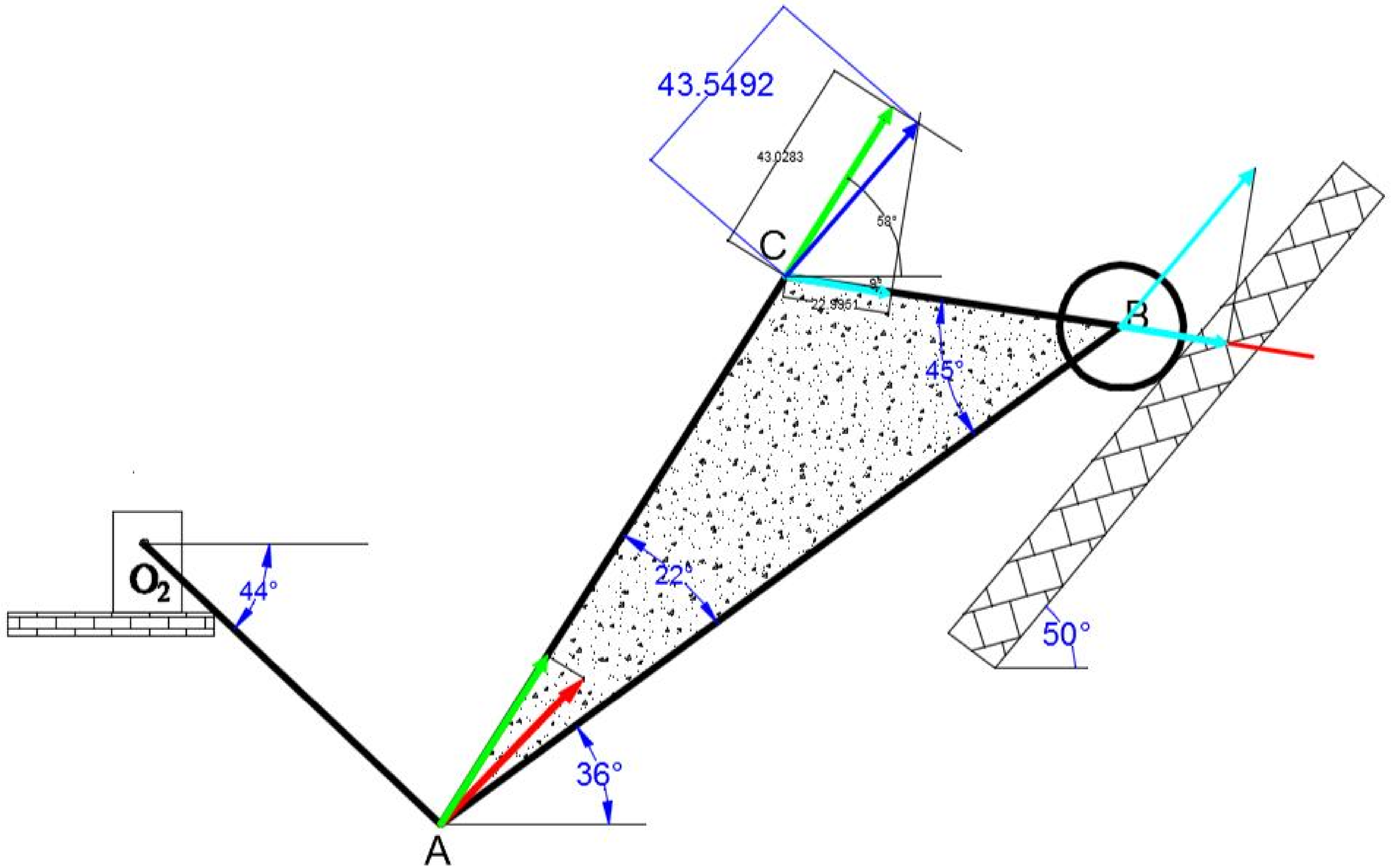

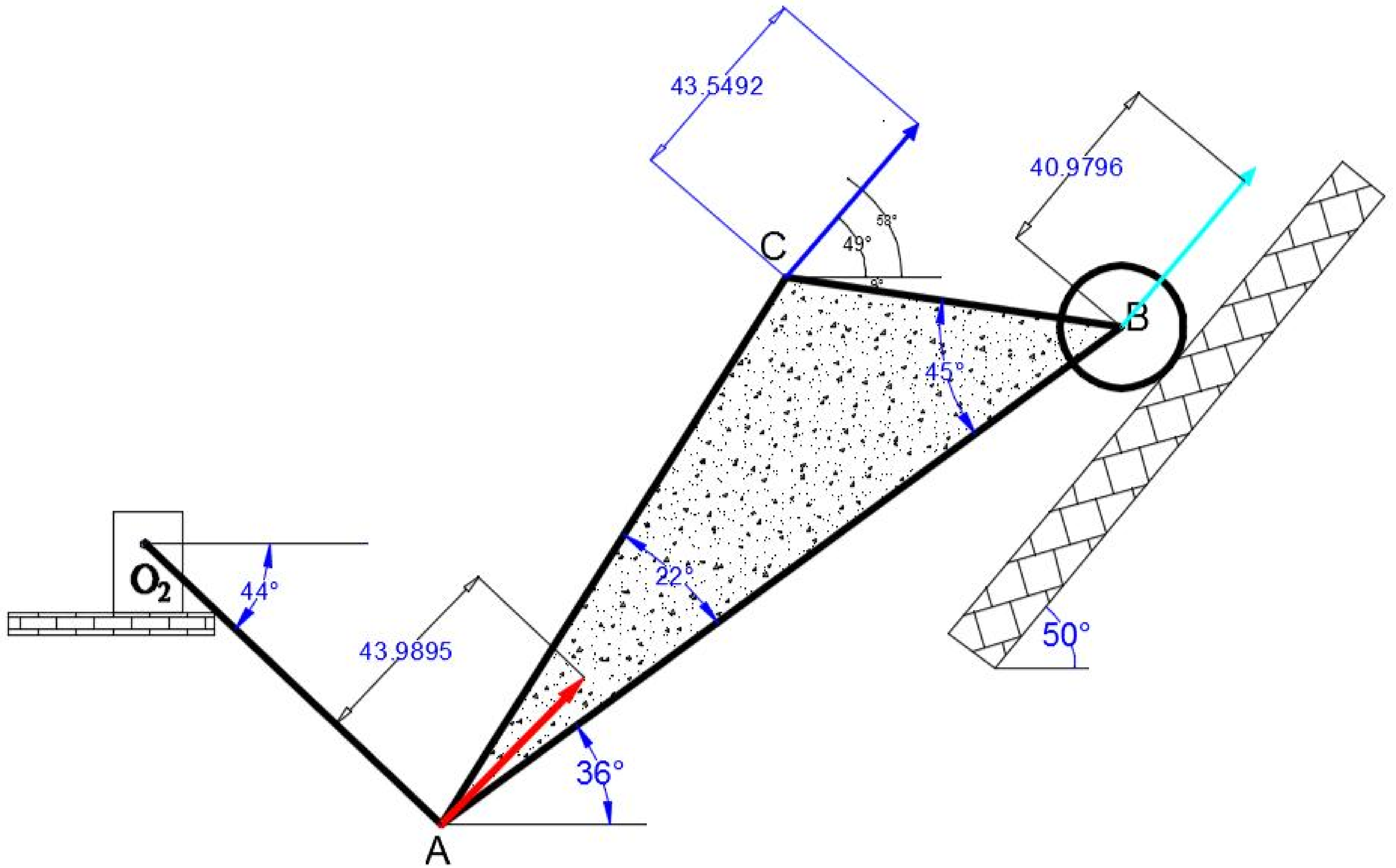

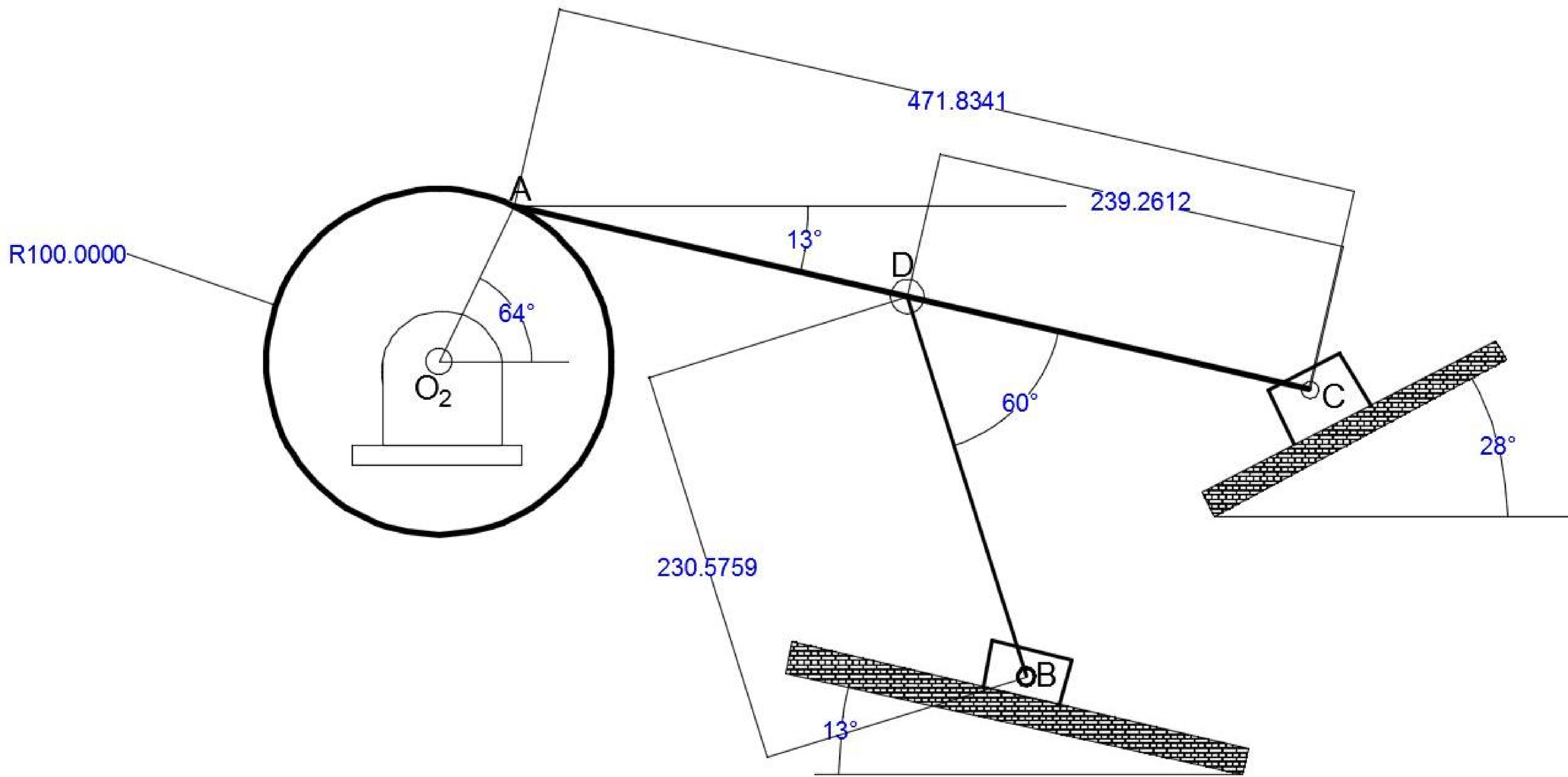

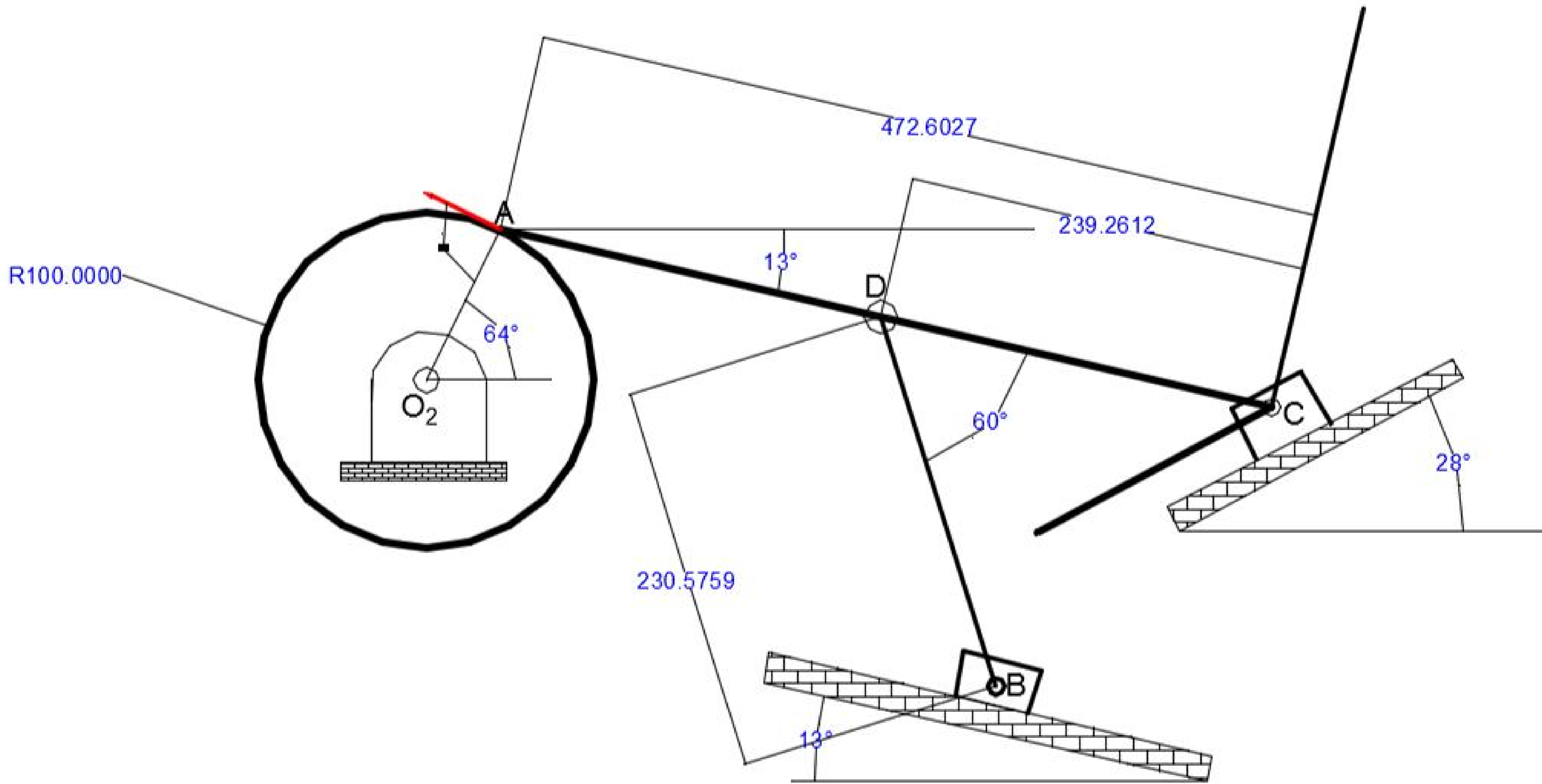



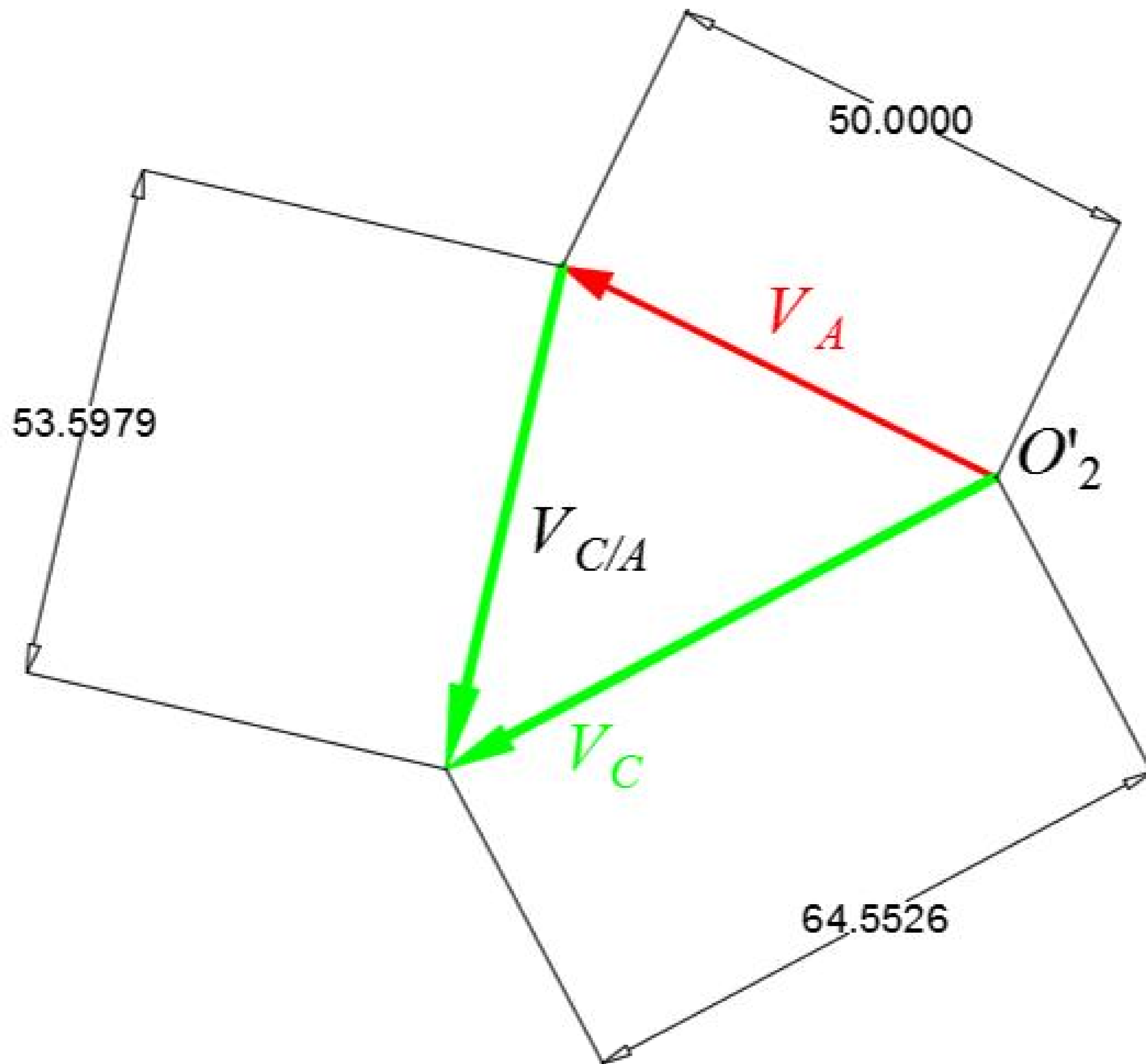

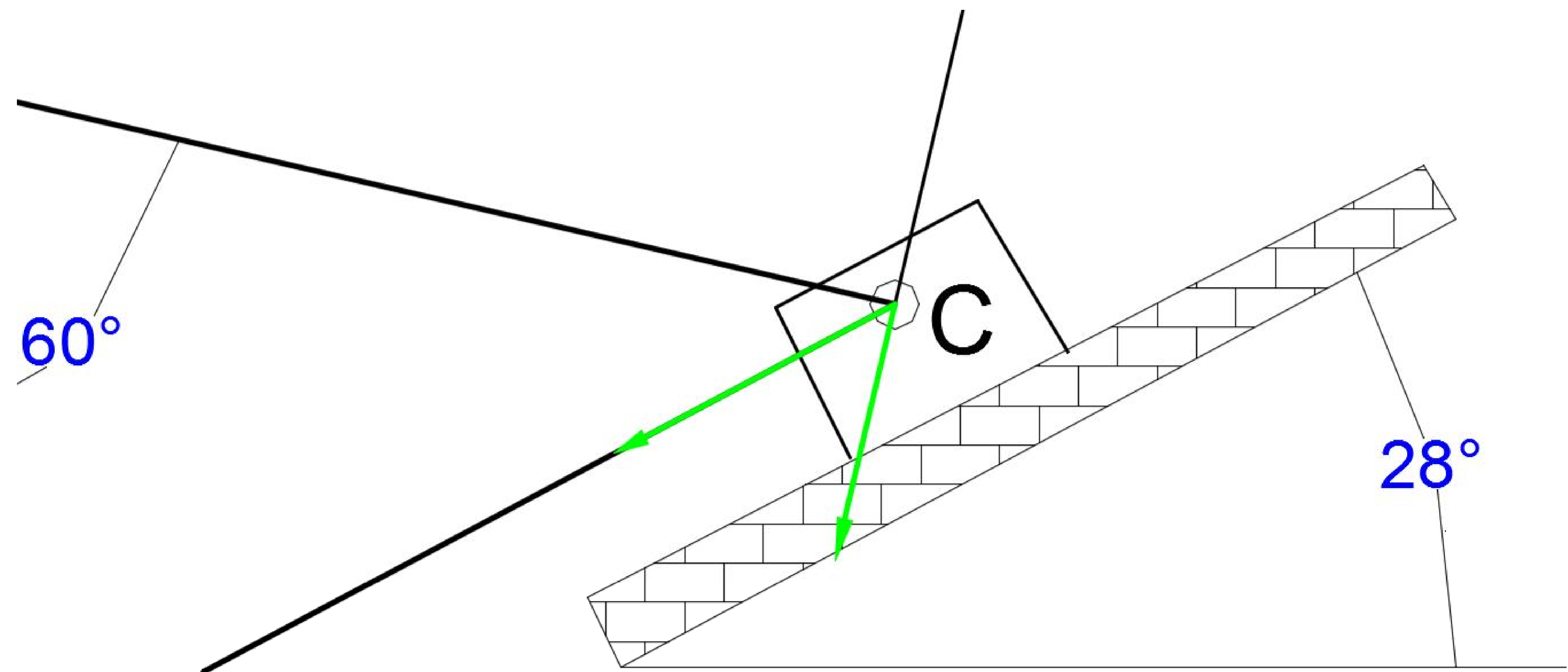

60°

28°

C

<

